



Folding arm awnings

Family Classic
Family Design
Family Compact

Family



Just
enjoy life!

Lewens
MARKISEN

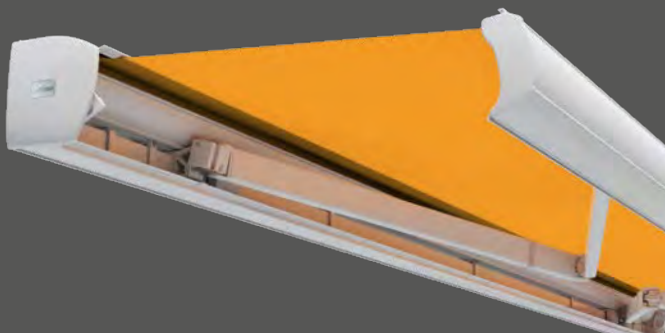



Quality

“made in Germany” – since 1998

The folding arm awnings of the Family series are among the classic products of the Lewens company. Designed on the basis of proven back bar technology, they offer a winning combination of reliability, sturdiness, convenient operation and a host of optional features. Superb components and conscientious workmanship guarantee the longevity of the Family awnings.

Based in Ludwigslust, Lewens has been manufacturing high-quality awning and glass roof systems for 25 years. These range from simple to complex to suit every application and are always accurate to the centimetre.

Lewens' production is a fully-integrated operation - from the design and making up of the fabric to assembly – situated on a site covering over 30000 m². High-grade materials, well thought-out design and precision in cutting and parts production, together with computer-aided automation in the manufacturing process, form the basis for products characterised by their functional reliability.

Consultancy and sales are entrusted to competent retailers, along with installation and on-site servicing. This creates proximity to the customer and ensures optimal service, so that our customers can just enjoy life!



Quality “made in Germany”:

*all awnings and glass roofs from Lewens
are manufactured in Germany.*



Just
enjoy life!



Family Classic



4



6

Family Design



8

Family Compact

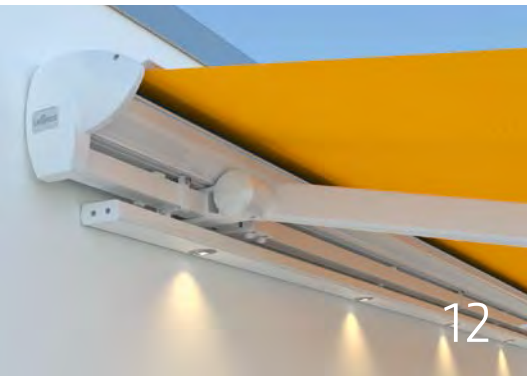

12

Comfort options



18

To match:
Micro 700

Contents

Models

Family Classic	4
Classic awning with valance	
Family Design	6
Designer profile	
Family Compact	8
Compact and close-fitting	

Equipment

Quality and technology	10
Focus on function and workmanship	
Comfort options	12
Vario Valance, Lewens-Matik, XXL arms, Electrics and wireless	
Fabrics and colours	14
Fabric collection and choice of frame colours	
Technical data	16
at a glance	

To match

Micro 700	18
Side screen awning	



Vario Valance (Option)

The Vario Valance offers variable shade from the sun and glare protection, especially when the sun is low in the sky, without any loss of headroom under the awning.

Family Classic – the classic awning

Versatile and practical for patios and outdoor seating areas



Open type

On the basic Family Classic type, the awning fabric roller is exposed ("open"). Round end caps at the sides and the fabric cover shell on the front of the fabric roller lend the awning a harmonious appearance.



A host of extra features

- Width of 1 unit max. 700 cm, joined system max. 1950 cm, drop max. 400 cm
- Supplied as standard with classic valance
- Electric motor
- Options:
Radio motor/
radio remote control,
automatic weather sensor,
LED lighting,
radiant heater,
support legs,
Vario Valance,
Lewens-Matik



Lewens-Matik (Option)

An additional crank gear mechanism permits smooth adjustment of the awning pitch to adapt it to the position of the sun.

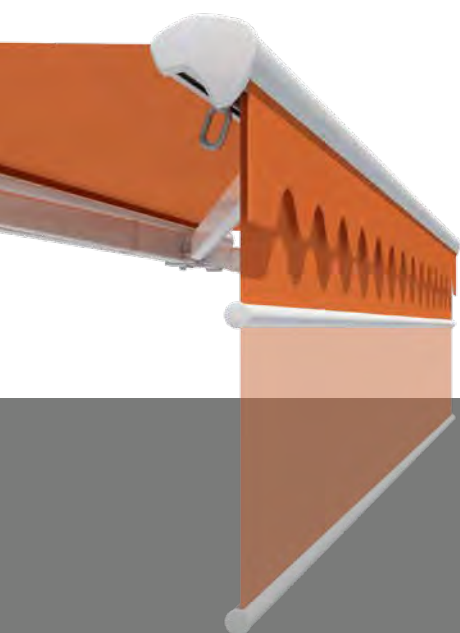

The Family Classic folding arm awning with its typical valance creates a summer-like atmosphere on the patio or balcony. Available in formats up to 700 cm (as a single unit) and up to 1950 cm as a joined system, this awning is perfect even for large areas. A user-friendly awning boasting proven Lewens' quality, the Family Classic can be enhanced by a number of interesting options.

Rain Cover type

The protective cover on the Family Classic Rain Cover type protects the awning against dust, rain and other effects of the weather when retracted.



Encased type

Equipped with a protective cover and back plate, the Encased type of the Family Classic provides secure all-round protection for the fabric roller.



Family Design – shapely and technically perfect Designer awning for large patios and outdoor seating areas

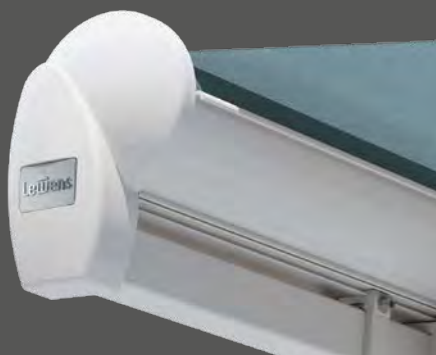

Open type

On the basic Family Design type, the awning fabric roller is exposed ("open"). Round end caps at the sides and the fabric cover shell on the front of the fabric roller give the awning a harmonious appearance.



The optimum in comfort

- Width of 1 unit max. 700 cm, joined system max. 1950 cm, drop max. 400 cm
- "Designer" front profile
- Electric motor
- Options:
Radio motor/radio remote control, automatic weather sensor, LED lighting, radiant heater, support legs



XXL arms *(Option)*

If only a small width is available for the awning and yet a large drop is required, the Family Design with its XXL arms, which overlap in two planes, is the perfect solution. Can be supplied for all types: Open, Rain Cover and Encased.



As the designer model among the back bar awnings, the Family Design adds a touch of style. The elegant front profile with smoothly rounded ends creates a modern façade. As well as superior Lewens quality and ease of operation, the awning comes with a range of attractive optional features.

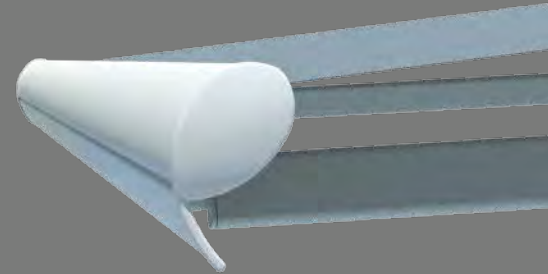

Rain Cover type

The protective cover on the Family Design Rain Cover type protects the awning against dust, rain and other effects of the weather when retracted.



Encased type

Equipped with a protective cover and back plate, the Encased type of the Family Design provides secure all-round protection for the fabric roller.



Sturdy and long-lasting
Arm bracket with support screw
and high-impact screw

A generous measure of comfort

- Width of 1 unit max. 650 cm, joined system max. 1950 cm, drop max. 350 cm
- Electric motor
- Options:
Radio motor/radio remote control,
automatic weather sensor,
LED lighting,
radiant heater,
support legs

Family Compact – compact and close-fitting

Ensuring privacy and shade on the balcony or patio

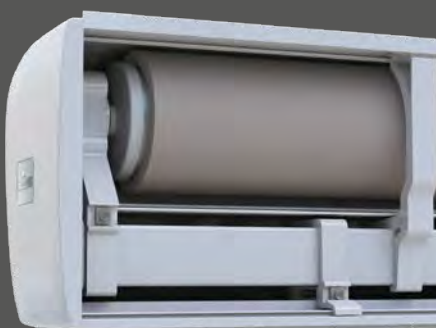

Semi-cassette type

Closed on three sides

The protective cover, base profile and close-fitting front profile protect the awning fabric and mechanism from the effects of the weather when the awning is retracted.





Compact design with a high degree of comfort and superb technical features.

Classic design, superior quality, ease of operation and high value retention: the Family Compact combines the protective function of a cassette awning with the ease of installation of a back bar awning.

Fits snugly against the wall for a clean façade look.



Cassette type

Closed on four sides

The protective casing for the awning turns the housing into a cassette, offering all-round protection for the roller.





With their proven, reliable technical features, careful attention to detail and variety of equipment options, back bar awnings from Lewens make a convincing impression. Centimetre-accurate manufacturing, even in intermediate sizes, ensures a perfect fit in virtually any desired location.



Quality and technology made in Germany



As a classic awning system from Lewens, the Family series is based on the tried and tested back bar concept:

All models are robust, durable high-quality awnings incorporating outstanding technical features, the best materials and careful workmanship. They are characterised by simple operation and versatile installation.

Durable and robust:

Arm bracket of high-strength aluminium alloy, upper arm fork of forged aluminium.

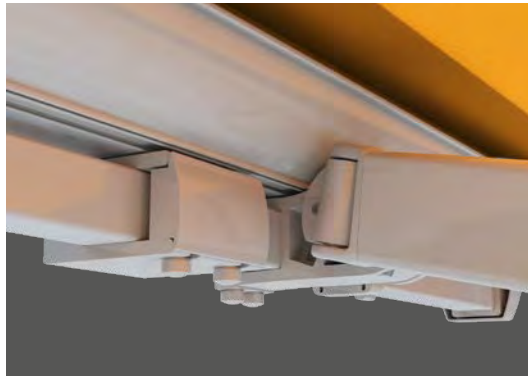

The **front profile bracket** connects the arms securely to the front profile and permits easy adjustment of the angle.

Central folding arm joints

A plastic sheath prevents soiling and corrosion of the double cable in the central folding arm joints and extends its service life.

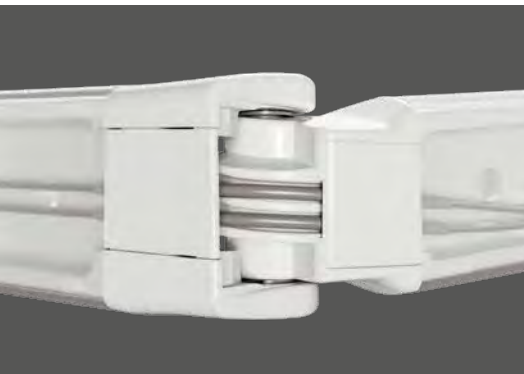
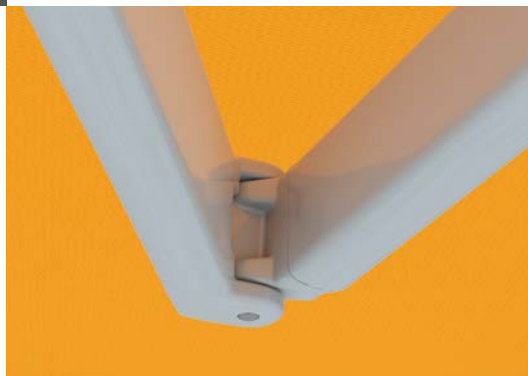

All double cables are greased for improved running with less friction.

The axle pins of the hinges consist of stainless Steel.

The extremely high **spring tension** of the folding arms guarantees a superbly taut sit of the fabric and largely prevents the awning fabric from resting on the arm hinges.



Guaranteed quality



TÜV-tested quality and CE standard:

Look out for the seal and the mark guaranteeing the technical safety of our products.



Branded goods from Germany:

Lewens awnings are manufactured and assembled in Germany – quality "made in Germany"!

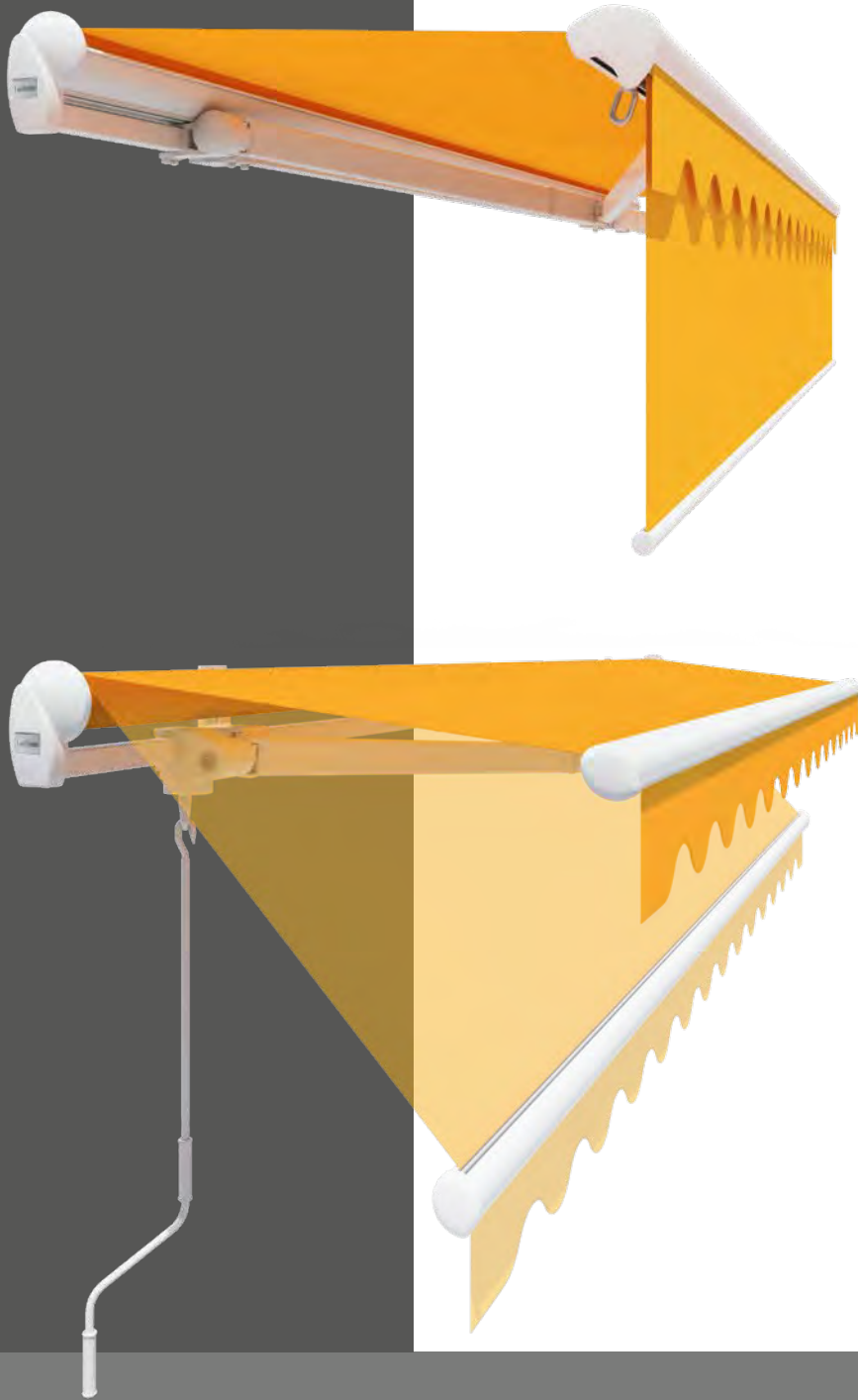

Vario Valance

Standard equipment

- Supplied as standard with crank operation and acrylic awning fabric
- Hanging height: 150 cm
- Always with additional short valance

For awnings up to a max. width of 600 cm

- Max. drop of 350 cm possible up to 550 cm width and from 569 to 600 cm width (3 arms)

Add-on features *(incur an extra charge)*

- Polyester fabric (valance length 150 cm), Soltis Perform 92 (valance length 150 cm), Orchestra MAX (valance length 120 cm)
- Vario valance with radio-controlled motor (only for awnings with radio-controlled motor); valance length then 150 cm in acrylic/polyester, 150 cm in Soltis Perform 92, 120 cm in Orchestra MAX

Cannot be used in combination with Lewens-Matik and/or radiant heater.

Lewens-Matik

- Awning pitch 5° - 52° (infinitely variable)
- For awnings up to 600 x 350 cm
- Pitch adjustment by means of crank drive

Cannot be used in combination with Vario Valance and/or radiant heater.

Options

Family Classic

The **Vario Valance** offers variable shade from the sun and privacy while retaining the head-room below the awning. When the awning is retracted, the Vario Valance can also be used as a window blind, creating shade and a cool climate inside.

The **Lewens-Matik** offers the option of adjusting the awning pitch smoothly to adapt it to the position of the sun.

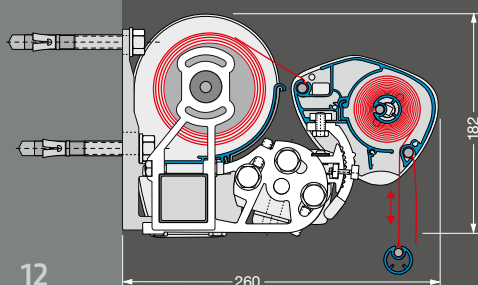

Family Classic Open type
with Vario Valance option

Lewens-Matik option
Crank gear for adjusting
the pitch angle

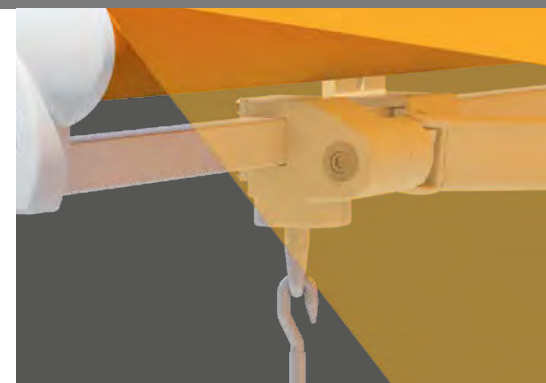



Radio controllers

create the prerequisites for integrating all patio functions into the home automation system, with convenient operation by tablet or smartphone.



Automatic weather sensor

Sun, wind and rain sensors ensure automatic, weather-dependent control of awnings – even when there's no one at home.



Infrared radiant heaters

create a cosy atmosphere and pleasant warmth under awnings and glass roofs, even on chilly days.



Options

Electrical

Want more than the wall switch for operation and other comfort features too? Then you have the choice of radio control systems, lighting, radiant heater and automatic weather sensor components meeting the contemporary standard, which can all be integrated into the home automation system. All patio functions can thus be conveniently operated via tablet or smartphone.



LED lighting

Equipped with a radio receiver, suitable mood lighting for any situation can be created by remote control or via the home automation system.

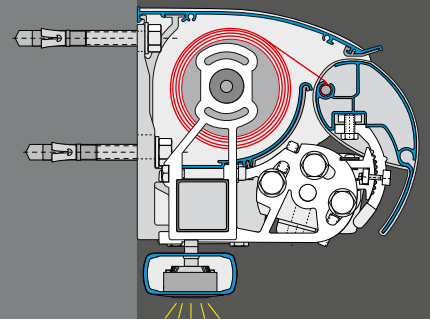



Standard colours: RAL colours and textured finishes (SL) **at no extra charge**



Colour differences may result from the printing process. We strongly recommend a comparison with our original colour samples.

Frame colours to order

The frames of Lewens awnings and glass roofs are given a high-grade powder coating, rendering them particularly UV- and weather-resistant. An optional preanodising treatment increases the durability of the coating for products used in coastal regions. Hundreds of RAL colours and textured finishes (SL) are available to choose from, including a wide range of contemporary colours offered as standard at no extra charge.

As well as powder-coated finishes, the frames of nearly all models are also offered in **natural silver**.

Finish: frame in **E6/EV1 silver anodised**, small components such as hinge parts, brackets etc. powder-coated in silver RAL 9006.



The Lewens collection offers you high-quality acrylic and polyester fabrics that are solution-dyed to retain their colour brilliance for longer, wovens containing 85% recycled polyester from PET bottles as well as partly transparent glass fibre screen fabrics and Soltis Perform 92.

Lewens awning fabrics have been created especially for use outdoors and are treated to make them water- and dirt-repellent. We make the awnings up using the latest sewing techniques for distortion-free seams and also using ultrasonic bonding. We have designed our manufacturing facility so that the awning fabrics can be laid out entirely flat (not folded) for making up.

Some of our quality features:

- Secure lockstitch used for making up, optionally also with ultrasonically bonded seam (surcharge).
- Awning and valance are produced from one piece (identical repeat pattern)
- Seams on top and bottom and valance seam neatened (clean completion)
- Repeat-symmetrical completion left and right
- Use of Tenara® quality sewing yarn (also for valances)

The Collection

Fabrics ranging
from modern to classic

Valance styles



Style 1



Style 2



Style 3



Style 4

Family

Equipment and technical features



Manufactured and assembled in Germany
TÜV-tested safety
Quality and technology CE-compliant



Family Classic



Family Classic



Family Classic

Type	Open	Rain Cover	Encased
Back bar awning – standard dimensions, retracted (H x D)	182 x 200 mm	178 x 200 mm	178 x 200 mm
Unit widths (max.)			
1 unit (single panel)	700 cm	700 cm	700 cm
2 units (linked system with continuous awning)	1.200 cm	–	–
2 units/3 units (linked system with slit cover)	1.300 cm/1.950 cm	1.300 cm/1.950 cm	1.300 cm/1.950 cm
Drops			
Arm lengths 150 / 200 / 250 / 300 / 350 cm	■	■	■
Arm lengths 400 cm	■	■	■
Special arm lengths	□	□	□
Drive			
Electric motor (for wall switch)	■	■	■
Radio motor	□	□	□
Crank drive	□	□	□
Frame colours			
29 Lewens standard frame colours	■	■	■
Natural silver (E6/EV 1 anodized, small components RAL 9006)	■	■	■
Additional RAL, special colours and effect finishes	□	□	□
Awning fabrics from the LEWENS collection			
Branded acrylic (spun-dyed, ultra fade resistant)	■	■	■
Orchestra MAX (branded acrylic, water repellent), up to 600 x 350 cm *	□	□	□
Branded polyester/recycled polyester (spun-dyed, ultra fade resistant)	□	□	□
Tenara quality sewing yarn	■	■	■
Ultrasonic seam welding	□	□	□
Valance			
without valance	–	–	–
with valance	■	■	■
Options			
1 Radio motor + radio remote control	□	□	□
2 Automatic weather sensor (sun, wind, rain)	□	□	□
3 Lighting: LED spot bar	□	□	□
4 Radiant heater (not with 6, 7; with 3 only wall attachment)	□	□	□
5 Support legs (not with 2, 7)	□	□	□
6 Vario Valance, up to 600 cm wide (not with 4, 7)	□	□	□
7 Lewens-Matik, up to max. 600 x 350 cm (not with 3, 4, 5, 6)	□	□	□
8 XXL-arms (dependent on width/drop)	–	–	–
Attachment			
Wall	■	■	■
Ceiling/rafters	□	□	□

Possible dimensions and restrictions along with the complete range of electronic accessories can be found in the technical data in the current Lewens price list.

■ Standard □ Option – not available
* pitch angle ≥ 10° recommended, always ultrasonic seam welding

Family Classic Open type

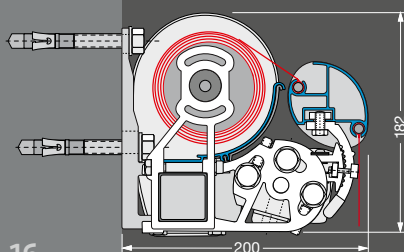

Family Classic Rain Cover type/
Encased type (not shown)

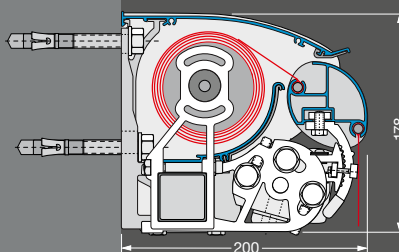

Family Design Open type

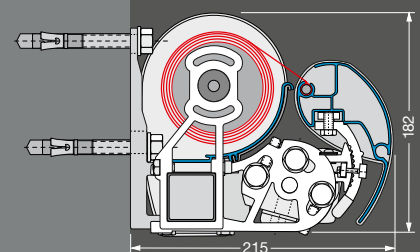



Family Design



Family Design



Family Design



Family Compact



Family Compact

Open	Rain Cover	Encased
182 x 215 mm	178 x 220 mm	178 x 220 mm
700 cm	700 cm	700 cm
1.200 cm	-	-
1.300 cm/1.950 cm	1.300 cm/1.950 cm	1.300 cm/1.950 cm
■	■	■
■	■	■
□	□	□
■	■	■
□	□	□
□	□	□
■	■	■
■	■	■
□	□	□
■	■	■
□	□	□
□	□	□
■	■	■
□	□	□
■	■	■
□	□	□
□ [XXL-arms: ■]	□ [XXL-arms: ■]	□ [XXL-arms: ■]
□	□	□
□	□	□
□	□	□
□	□	□
□	□	□
-	-	-
-	-	-
□	□	□
■	■	■
□	□	□

Semi-cassette	Cassette
200 x 200 mm	200 x 200 mm
650 cm	650 cm
-	-
1.300 cm/1.950 cm	1.300 cm/1.950 cm
■	■
-	-
□	□
■	■
□	□
□	□
■	■
■	■
□	□
■	■
□	□
□	□
■	■
□	□
□	□
□	□
□	□
-	-
-	-
■	■
□	□

Possible dimensions and restrictions along with the complete range of electronic accessories can be found in the technical data in the current Lewens price list.

■ Standard □ Option - not available

Family Design Rain Cover type/
Encased type (not shown)

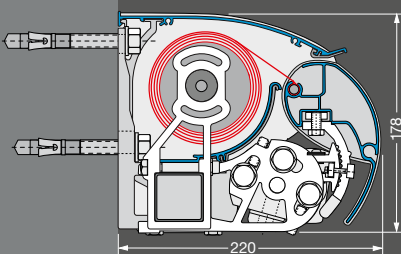

Family Compact Semi-cassette type

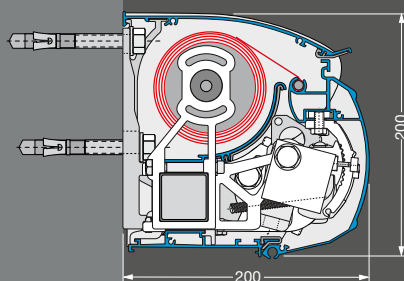

Family Compact Cassette type

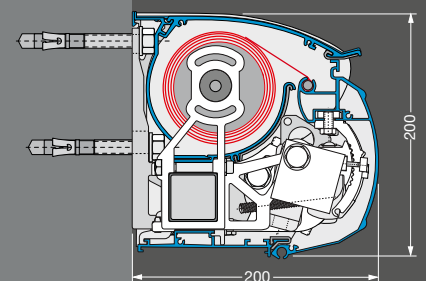

TO MATCH:



Micro 700 – side screen awning

The perfect complement to the folding arm awning

*The Micro 700 is simply extended using the **handle** (position and number optional) and hooked onto the wall mounting or post.*

*The **bottom castor** enables the awning to be guided easily. The awning shaft is fitted with an anti-kickback brake for safe, convenient operation.*



Wall cassette (W x D)	108,8 x 100,6 mm		
Unit height (max.)			
1 unit (single panel)	250 cm		
Extension (max., depending on fabric and height)	Height up to 134 cm	Up to 190 cm	Up to 250 cm
Acrylic/(recycled) polyester	400 cm	*300 cm	*300 cm
Soltis Perform 92	400 cm	400 cm	*300 cm
Drive			
Manual operation, 1 handle	<input checked="" type="checkbox"/>		
Manual operation, further handles	<input type="checkbox"/>		
Frame colours			
29 Lewens standard frame colours	<input checked="" type="checkbox"/>		
Additional RAL, special colours and effect finishes	<input type="checkbox"/>		
Awning fabrics from the LEWENS collection			
Branded acrylic (spun-dyed, ultra fade resistant)	<input checked="" type="checkbox"/>		
Soltis Perform 92	<input checked="" type="checkbox"/>		
Branded polyester/recycled polyester (spun-dyed, ultra fade resistant)	<input type="checkbox"/>		
Tenara quality sewing yarn	<input checked="" type="checkbox"/>		
Ultrasonic seam welding	<input type="checkbox"/>		

Possible dimensions and restrictions along with complete range of accessories can be found in the technical data in the current Lewens price list.

Standard Option
* only with vertical panel direction

The Micro 700 side screen awning provides shelter from the sun, wind and unwanted attention, creating a snug refuge on the patio, balcony or loggia. The Micro 700 complements the conventional sunshade in terms of function and design. The fabrics of all Lewens products can be perfectly coordinated with one another.

When the awning is retracted, the cassette can simply be removed from the bracket to prevent theft or vandalism and can be stored safely until it is next used.

Installation

Wall mounting (standard)



Screwed to base

(instead of standard)



Screwed to base

with base console





www.lewens-markisen.de



Your stockist will be happy to advise you: